

Buckling Strength of Stiffened Plates Containing One Longitudinal or Transverse Girder under Compression

著者	Okada Hiroo, Kitaura Ken'ichi, Fukumoto Yoshio
引用	Bulletin of University of Osaka Prefecture. Series A, Engineering and natural sciences. 1972, 20(2), p.287-306
URL	http://doi.org/10.24729/00008806

Buckling Strength of Stiffened Plates Containing One Longitudinal or Transverse Girder under Compression

Hiroo OKADA,* Ken-ichi KITAURA* and Yoshio FUKUMOTO*

(Received November 15, 1971)

The buckling strength of stiffened plates containing one longitudinal or transverse girder under compression, is discussed in this paper. The stiffened plate is idealized by an equivalent orthotropic plate. Non-dimensional design table giving the critical stress for the symmetric buckling of the system are presented for different values of virtual aspect ratio, the effective torsional rigidity of stiffened plate and girder characteristics. And the curves of the limiting value γ_0 corresponding to the minimum value of the flexural rigidity of the girder which just guarantees antisymmetric buckling of the system are also presented. At the same time, the effective breadth of the stiffened plate which cooperates with the girder and is necessary in the calculation of the flexural rigidity of the girder, is also calculated.

1. Introduction

This study is concerned with the basic structural element used in ship and marine structures, that is, the plate-stiffener combination. In this place, we consider the elastic strength of a longitudinally compressed rectangular plate which is reinforced by orthogonally intersecting stiffeners and one longitudinal girder or transverse girder on the center line. The plate reinforced by orthogonally intersecting stiffeners is idealized by an equivalent orthotropic plate.

In this plate-stiffener combination system idealized by the equivalent orthotropic plate system, there are two typical forms of the displacement of the buckled system according to the magnitude of the flexural rigidity of the girder; (1) a symmetric configuration with the deflected girder, (2) an antisymmetric configuration where the girder remains straight. The buckled plate has in the latter case nodal line coinciding with the axis of the girder. (It is assumed that the local buckling of the girder will never occur.)

In general, when the flexural rigidity EI of the girder is small, the symmetric displacement form in which the girder deflects with the orthotropic plate will occur. The antisymmetric displacement form will occur when the flexural rigidity EI is larger than a certain value EI_0 . The critical stress in this case does not depend on EI , but it is consistent with that of a simply supported orthotropic plate of a half width (for longitudinal girder) or a half length (for transverse girder). The buckling load of the orthotropic plate containing the girder, reaches in this case its maximum values. At the flexural rigidity EI_0 , both configurations are equally possible.

In 2-1. or 2-2., we study the symmetric buckling for values $EI < EI_0$ and determine

* Department of Naval Architecture, College of Engineering.

the limiting value EI_0 of the flexural rigidity of the girder which just guarantees the anti-symmetric buckling of the orthotropic plate containing a longitudinal girder or transverse girder. And in 2-3., for the calculation of the flexural rigidity EI of the girder in such cases as the girder is attached to one side of the plate and is unsymmetry with respect to the middle plane of the plate, the effective breadth of the orthotropic plate which cooperates with girder is calculated. In 3., the practical application method of the theory on the orthotropic plate system to the plate-stiffener combination system, is shown.

2. Theory on Orthotropic Plate

2-1. Simply supported orthotropic plates having one longitudinal girder on the center line.

Consider a simply supported rectangular orthotropic plate of length a , width b , and thickness t , which is reinforced by a longitudinal girder on the center line (see Fig. 1(a)). The area of the cross section of the girder is A , and its moment of inertia I . It is assumed that the center line of the girder lies in the middle plane of the plate, and the moment of inertia I , therefore, refers to the axis of the girder in this plane. The torsional rigidity of the girder is regarded as small and will be neglected. We select a system of coordinates x, y, z having its origin O in the center of the left edge of the plate. The plate is loaded by a uniformly distributed load p acting on the edges $x=0$ and $x=a$. It is assumed that the girder is fixed to the plate and has the same compressive stress p as the plate.

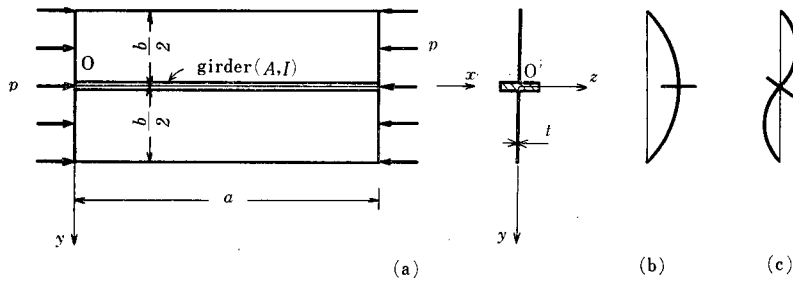

Fig. 1 Buckling of the simply supported orthotropic plate having one longitudinal girder on the center line.

As stated in 1., a symmetric configuration with deflected girder (Fig. 1(b)) will occur when the flexural rigidity EI is small, and an antisymmetric configuration where girder remains straight (Fig. 1(c)) will occur when EI is larger than a certain value EI_0 .

In this place, we investigate the symmetric configuration of the buckled plate in order to derive the condition of instability. The relations between the stress and strain components for the orthotropic plate can be represented by the following equation in this coordinate system;

$$\begin{pmatrix} \sigma_x \\ \sigma_y \\ \tau_{xy} \end{pmatrix} = \frac{1}{(1-\nu_x\nu_y)} \begin{pmatrix} E_x & \nu_y E_x & 0 \\ \nu_x E_y & E_y & 0 \\ 0 & 0 & G(1-\nu_x\nu_y) \end{pmatrix} \begin{pmatrix} \epsilon_x \\ \epsilon_y \\ \gamma_{xy} \end{pmatrix} \quad (1)$$

where $\nu_x E_y = \nu_y E_x$.

Requiring equilibrium of forces in the z direction, the equilibrium equation can be written in the form;

$$D_x \frac{\partial^4 w_1}{\partial x^4} + 2H \frac{\partial^4 w_1}{\partial x^2 \partial y^2} + D_y \frac{\partial^4 w_1}{\partial y^4} + pt \frac{\partial^2 w_1}{\partial x^2} = 0 \tag{2}$$

where w_1 = the deflection of the lower half of the plate, ($y \geq 0$)

$$D_x = E_x t^3 / \{12(1 - \nu_x \nu_y)\}, \quad D_y = E_y t^3 / \{12(1 - \nu_x \nu_y)\}$$

$$2H = Gt^3 / 3 + \nu_x D_y + \nu_y D_x.$$

The deflection w_1 must satisfy the Eq. (2) and the following boundary conditions;

$$w_1 = 0 \quad \frac{\partial^2 w_1}{\partial x^2} = 0 \quad \text{for } x = 0 \text{ and } x = a. \tag{3}$$

We take the solution of Eq. (2) in the form

$$w_1 = Y(y) \sin \frac{n\pi}{a} x \tag{4}$$

then, Eq. (2) requires that $Y(y)$ takes a form as

$$Y(y) = C_1 \cosh u_1 y + C_2 \sinh u_1 y + C_3 \cos u_2 y + C_4 \sin u_2 y \tag{5}$$

where

$$\left. \begin{aligned} u_1 b &= (n\pi/\alpha_0) \sqrt{\eta + \sqrt{\eta^2 + K\alpha_0^2/n^2 - 1}} \\ u_2 b &= (n\pi/\alpha_0) \sqrt{-\eta + \sqrt{\eta^2 + K\alpha_0^2/n^2 - 1}} \\ \alpha_0 &= (a/b) \sqrt[4]{D_y/D_x}, \quad \eta = H/\sqrt{D_x D_y} \\ K &= ptb^2/(\pi^2 \sqrt{D_x D_y}) \\ C_1 \text{ to } C_4 &= \text{integral constants.} \end{aligned} \right\} \tag{6}$$

The four constants C_1 to C_4 in Eq. (5) will be determined from the following boundary conditions;

$$w_1 = \frac{\partial^2 w_1}{\partial y^2} = 0 \quad \text{for } y = b/2 \tag{7}$$

$$\frac{\partial w_1}{\partial y} = 0 \quad \text{for } y = 0 \tag{8}$$

$$\bar{Q}_1 - \bar{Q}_2 = q \quad \text{for } y = 0 \tag{9}$$

in which q represents the vertical forces per unit length acting on the girder.

By \bar{Q}_1 and \bar{Q}_2 we denote the equivalent shearing forces per unit length in the plates adjacent to the girder (see Fig. 2). The load q is

$$q = \bar{Q}_1 - \bar{Q}_2$$

$$= \left[- \left\{ D_y \frac{\partial^3 w_1}{\partial y^3} + (H + 2D_{xy}) \frac{\partial^3 w_1}{\partial x^2 \partial y} \right\} + \left\{ D_y \frac{\partial^3 w_2}{\partial y^3} + (H + 2D_{xy}) \frac{\partial^3 w_2}{\partial x^2 \partial y} \right\} \right]_{y=0} \tag{a}$$

where w_2 = the deflections of the upper half of the plate, ($y \leq 0$)

$$D_{xy} = Gt^3 / 12.$$

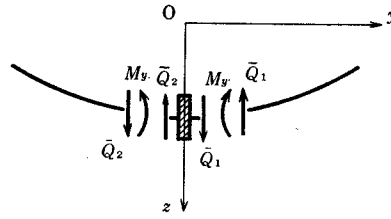

Fig. 2 The vertical forces acting on the girder.

Because of the symmetry, we have the relations

$$\frac{\partial^2 w_1}{\partial x^2} = \frac{\partial^2 w_2}{\partial x^2}, \quad \frac{\partial^3 w_1}{\partial y^3} = -\frac{\partial^3 w_2}{\partial y^3} \quad \text{for } y=0 \tag{b}$$

and therefore

$$q = -2D_y \left[\frac{\partial^3 w_1}{\partial y^3} \right]_{y=0} \tag{c}$$

Taking account of the axial load pA in the girder, the differential equation for its deflection w is

$$EI \frac{\partial^4 w}{\partial x^4} + pA \frac{\partial^2 w}{\partial x^2} = q \tag{10}$$

Considering Eq. (c) and $w = [w_1]_{y=0}$, Eq. (9) is

$$\left[EI \frac{\partial^4 w_1}{\partial x^4} + pA \frac{\partial^2 w_1}{\partial x^2} + 2D_y \frac{\partial^3 w_1}{\partial y^3} \right]_{y=0} = 0 \tag{11}$$

Introducing the solution (4), (5) into the boundary conditions (7), (8) and (11), we arrived at the four homogeneous equations for the constants C_1 to C_4 . The determinant of the system of equations furnishes the stability condition for the symmetric mode of buckling;

$$2(\alpha_0/n\pi)^4 (u_1^2 b^2 + u_2^2 b^2) - \left\{ \frac{\tanh(u_1 b/2)}{u_1 b} - \frac{\tan(u_2 b/2)}{u_2 b} \right\} \{ \gamma - K\delta(\alpha_0/n)^2 \} = 0 \tag{12}$$

where

$$\gamma = EI/(D_x b), \quad \delta = A/(bt) \tag{13}$$

The coefficient γ is the ratio of the flexural rigidity of the girder to that of the plate of width b in the x direction, and δ is the ratio of the cross-sectional area of the girder to the area bt of the plate.

The critical stress p_{os} for the symmetric buckling (Fig. 1(b)) is given by the minimum value of p with respect to the number n of half waves in Eq. (12). The numerical results are shown in Table 1-1 to Table 1-6 by using the plate factor K in Eq. (6), namely

$$p_{os} = \{ \pi^2 \sqrt{D_x D_y} / (tb^2) \} K.$$

As an example, the values of K for the effective torsional rigidity coefficient $\eta=0.6$ are plotted against the virtual aspect ratio α_0 for various values of γ and δ in Fig. 3. And the

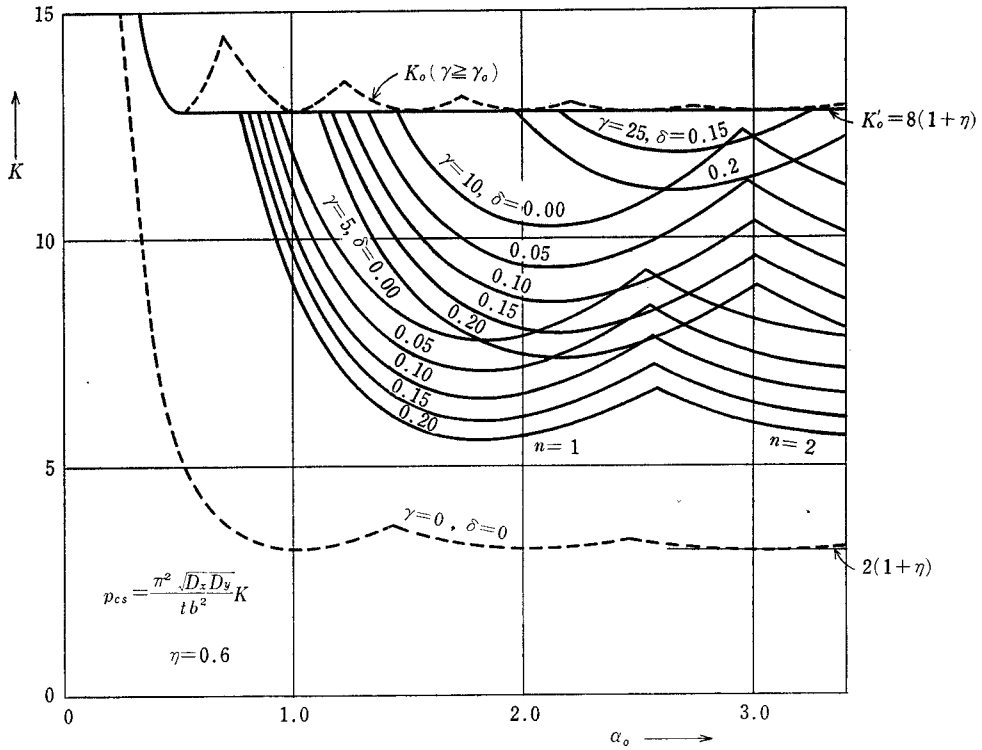

Fig. 3 The critical stress of the simply supported orthotropic plate having one longitudinal girder on the center line (in the case of $\eta=0.6$).

result for the case of the girderless plate ($\gamma=0, \delta=0$) is shown by broken line in the diagram.

It is apparent from the Table 1-1 to Table 1-6 or Fig. 3 that for the constant value of η , according to the increase of γ keeping the value of δ fixed, the values of K are increased, while according to the increase of δ keeping the values of γ fixed, the values of K are decreased. For the constant values of γ and δ , according to the increase of η , the values of K are increased.

In the antisymmetric configuration, each panel of the plate behaves like a simply supported plate of the width $b/2$ and the critical stress p_{oa} in this case is

$$p_{oa} = \{ \pi^2 \sqrt{D_x D_y} / (t b^2) \} K_0 \tag{14}$$

where

$$K_0 = 4 [(2\alpha_0/n_1)^2 + 2\eta + \{ n_1 / (2\alpha_0) \}^2] \tag{15}$$

n_1 = number of half wave for antisymmetric buckling in the x direction.

For the value of $\alpha_0 > 0.5$, the value K_0 is close to the value $8(1+\eta)$ and this value $K'_0 = 8(1+\eta)$ is shown in Table 1-1 to Table 1-6 and Fig. 3 in addition to K values corresponding to p_{cs} .

As stated above, when γ is small, p_{cs} is smaller than p_{oa} and then, the symmetric buckling (Fig. 1(b)) occurs, and when γ is larger than a certain value γ_0 , p_{cs} is larger

Table 1-1 and Table 1-2

The critical stress of the simply supported orthotropic plate having one longitudinal girder on the center line ($\eta=0.0$ and $\eta=0.2$).

The values of K are shown as $p = \{\pi^2 \sqrt{D_x D_y} / (tb^2)\} K$.

$\eta=0.0, K_0'=8.0$

α_0	$\gamma=5$			$\gamma=10$			$\gamma=15$			$\gamma=20$			$\gamma=25$		
	$\delta=0.05$	$\delta=0.10$	$\delta=0.20$	$\delta=0.05$	$\delta=0.10$	$\delta=0.20$	$\delta=0.05$	$\delta=0.10$	$\delta=0.20$	$\delta=0.05$	$\delta=0.10$	$\delta=0.20$	$\delta=0.05$	$\delta=0.10$	$\delta=0.20$
0.6															
0.8															
1.0															
1.2	7.90	7.31	6.35												
1.4	6.75	6.22	5.36												
1.6	6.18	5.68	4.88												
1.8	6.01	5.51	4.74												
2.0	6.12	5.62	4.82												
2.2	6.46	5.93	5.08												
2.4	6.97	6.39	5.48												
2.6	7.24	6.68	5.77												
2.8	6.75	6.22	5.36												
3.0	6.40	5.89	5.07												
3.2	6.18	5.68	4.88												
3.4	6.05	5.56	4.77												

N.B. In the blank part, the value K is equal to K_0' .

$\eta=0.2, K_0'=9.6$

α_0	$\gamma=5$			$\gamma=10$			$\gamma=15$			$\gamma=20$			$\gamma=25$		
	$\delta=0.05$	$\delta=0.10$	$\delta=0.20$	$\delta=0.05$	$\delta=0.10$	$\delta=0.20$	$\delta=0.05$	$\delta=0.10$	$\delta=0.20$	$\delta=0.05$	$\delta=0.10$	$\delta=0.20$	$\delta=0.05$	$\delta=0.10$	$\delta=0.20$
0.6															
0.8															
1.0		9.58	8.42												
1.2	8.28	7.66	6.64												
1.4	7.12	6.55	5.65												
1.6	6.54	6.01	5.17												
1.8	6.37	5.85	5.02												
2.0	6.49	5.95	5.11												
2.2	6.82	6.26	5.37												
2.4	7.33	6.72	5.76												
2.6	7.61	7.02	6.07												
2.8	7.12	6.55	5.65												
3.0	6.77	6.23	5.36												
3.2	6.54	6.01	5.17												
3.4	6.42	5.89	5.06												

N.B. In the blank part, the value K is equal to K_0' .

Table 1-3 and Table 1-4

The critical stress of the simply supported orthotropic plate having one longitudinal girder on the center line ($\eta=0.4$ and $\eta=0.6$).

The values of K are shown as $p = \{\pi^2 \sqrt{D_x D_y} / (tb^2)\} K$.

$\eta=0.4, K_0'=11.2$

α_0	$\gamma=5$			$\gamma=10$			$\gamma=15$			$\gamma=20$			$\gamma=25$		
	$\delta=0.05$	$\delta=0.10$	$\delta=0.20$	$\delta=0.05$	$\delta=0.10$	$\delta=0.20$	$\delta=0.05$	$\delta=0.10$	$\delta=0.20$	$\delta=0.05$	$\delta=0.10$	$\delta=0.20$	$\delta=0.05$	$\delta=0.10$	$\delta=0.20$
0.6															
0.8															
1.0	10.68	9.95	8.74												
1.2	8.66	8.00	6.94												
1.4	7.49	6.89	5.94		10.84	9.41									
1.6	6.91	6.35	5.46	10.28	9.48	8.18			10.83						
1.8	6.73	6.18	5.31	9.46	8.70	7.48		11.16	9.63						
2.0	6.85	6.29	5.39	9.08	8.34	7.17		10.37	8.93			10.66			
2.2	7.19	6.59	5.65	9.04	8.30	7.12	10.86	9.99	8.59			10.04			
2.4	7.70	7.06	6.05	9.27	8.50	7.29	10.82	9.93	8.52			9.74			10.98
2.6	7.98	7.36	6.36	9.69	8.89	7.62	11.02	10.11	8.68			9.73			10.77
2.8	7.49	6.90	5.94	10.29	9.43	8.08		10.49	9.00			9.90			10.82
3.0	7.14	6.56	5.65	10.90	10.08	8.68		11.04	9.46			10.25			11.05
3.2	6.91	6.35	5.46	10.28	9.47	8.18			10.05			10.75			
3.4	6.77	6.23	5.35	9.80	9.02	7.77			10.16						

N.B. In the blank part, the value K is equal to K_0' .

$\eta=0.6, K_0'=12.8$

α_0	$\gamma=5$			$\gamma=10$			$\gamma=15$			$\gamma=20$			$\gamma=25$		
	$\delta=0.05$	$\delta=0.10$	$\delta=0.20$	$\delta=0.05$	$\delta=0.10$	$\delta=0.20$	$\delta=0.05$	$\delta=0.10$	$\delta=0.20$	$\delta=0.05$	$\delta=0.10$	$\delta=0.20$	$\delta=0.05$	$\delta=0.10$	$\delta=0.20$
0.6															
0.8			12.07												
1.0	11.09	10.32	9.05												
1.2	9.04	8.35	7.23			11.74									
1.4	7.86	7.24	6.26	12.10	11.19	9.71									
1.6	7.28	6.69	5.75	10.64	9.81	8.47			11.13						
1.8	7.10	6.52	5.59	9.82	9.03	7.78	12.48	11.50	9.91			12.03			
2.0	7.22	6.62	5.68	9.45	8.68	7.45	11.64	10.71	9.21		12.71	10.96			12.68
2.2	7.56	6.92	5.94	9.41	8.64	7.41	11.24	10.33	8.89		12.00	10.33			11.77
2.4	8.02	7.39	6.33	9.62	8.83	7.58	11.18	10.27	8.81	12.72	11.69	10.04			11.26
2.6	8.35	7.70	6.65	10.05	9.22	7.90	11.39	10.45	8.96	12.71	11.66	10.01			11.07
2.8	7.86	7.23	6.23	10.65	9.76	8.37	11.80	10.82	9.28		11.88	10.19			11.10
3.0	7.50	6.90	5.94	11.28	10.41	8.95	12.40	11.37	9.74		12.29	10.54			11.33
3.2	7.27	6.68	5.74	10.65	9.81	8.47		12.06	10.33			11.03			11.73
3.4	7.14	6.56	5.63	10.17	9.35	8.06		12.09	10.45			11.66			12.27

N.B. In the blank part, the value K is equal to K_0' .

Table 1-5 and Table 1-6

The critical stress of the simply supported orthotropic plate having one longitudinal girder on the center line ($\eta=0.8$ and $\eta=1.0$).

The values of K are shown as $p = \{\pi^2 \sqrt{D_x D_y} / (tb^2)\} K$.

$\eta=0.8, K_0' = 14.4$

α_0	$\gamma=5$			$\gamma=10$			$\gamma=15$			$\gamma=20$			$\gamma=25$		
	$\delta=0.05$	$\delta=0.10$	$\delta=0.20$	$\delta=0.05$	$\delta=0.10$	$\delta=0.20$	$\delta=0.05$	$\delta=0.10$	$\delta=0.20$	$\delta=0.05$	$\delta=0.10$	$\delta=0.20$	$\delta=0.05$	$\delta=0.10$	$\delta=0.20$
0.6															
0.8		13.83	12.46												
1.0	11.48	10.69	9.36												
1.2	9.40	8.69	7.53		13.75	12.05									
1.4	8.22	7.57	6.52	12.47	11.54	10.00			13.35						
1.6	7.64	7.02	6.03	11.02	10.15	8.76	14.27	13.19	11.42			14.02			
1.8	7.47	6.85	5.88	10.19	9.37	8.06	12.84	11.83	10.21		14.26	12.32			
2.0	7.58	6.95	5.96	9.81	9.01	7.74	12.01	11.04	9.50	14.17	13.04	11.24			12.94
2.2	7.92	7.26	6.22	9.77	8.97	7.70	11.61	10.66	9.15	13.43	12.34	10.62		14.01	12.06
2.4	8.43	7.72	6.64	9.99	9.17	7.86	11.54	10.60	9.10	13.09	12.02	10.33		13.43	11.55
2.6	8.72	8.04	6.94	10.42	9.55	8.19	11.75	10.78	9.25	13.07	12.00	10.30	14.39	13.21	11.35
2.8	8.22	7.57	6.52	11.01	10.10	8.65	12.17	11.16	9.57	13.31	12.21	10.48		13.26	11.39
3.0	7.87	7.24	6.22	11.65	10.73	9.20	12.76	11.70	10.03	13.76	12.62	10.82		13.54	11.62
3.2	7.64	7.04	6.03	11.01	10.15	8.76	13.51	12.39	10.61		13.20	11.32		14.01	12.01
3.4	7.51	6.90	5.94	10.54	9.70	8.33	13.48	12.43	10.74		13.92	11.93			12.55

N.B. In the blank part, the value K is equal to K_0' .

$\eta=1.0, K_0' = 16.0$

α_0	$\gamma=5$			$\gamma=10$			$\gamma=15$			$\gamma=20$			$\gamma=25$		
	$\delta=0.05$	$\delta=0.10$	$\delta=0.20$	$\delta=0.05$	$\delta=0.10$	$\delta=0.20$	$\delta=0.05$	$\delta=0.10$	$\delta=0.20$	$\delta=0.05$	$\delta=0.10$	$\delta=0.20$	$\delta=0.05$	$\delta=0.10$	$\delta=0.20$
0.6															
0.8	15.08	14.28	12.84												
1.0	11.87	11.05	9.67			15.55									
1.2	9.78	9.04	7.82	15.16	14.12	12.37									
1.4	8.59	7.90	6.81	12.86	11.89	10.30		15.65	13.66						
1.6	8.01	7.35	6.32	11.39	10.50	9.05	14.65	13.54	11.72			14.33			
1.8	7.83	7.19	6.17	10.56	9.70	8.35	13.22	12.18	10.50	15.82	14.60	12.62			14.71
2.0	7.95	7.29	6.25	10.18	9.35	8.03	12.38	11.38	9.79	14.54	13.39	11.54		15.36	13.26
2.2	8.28	7.60	6.51	10.14	9.30	7.98	11.98	11.00	9.45	13.79	12.68	10.91	15.59	14.34	12.35
2.4	8.79	8.06	6.90	10.35	9.50	8.15	11.91	10.93	9.38	13.45	12.36	10.61	14.99	13.77	11.84
2.6	9.09	8.38	7.23	10.78	9.89	8.48	12.11	11.12	9.53	13.44	12.34	10.58	14.71	13.55	11.63
2.8	8.59	7.91	6.81	11.38	10.43	8.94	12.53	11.49	9.85	13.68	12.55	10.77	14.82	13.60	11.67
3.0	8.24	7.57	6.51	12.02	11.10	9.52	13.13	12.04	10.32	14.13	12.96	11.11	15.13	13.88	11.91
3.2	8.00	7.35	6.32	11.39	10.49	9.05	13.89	12.73	10.90	14.76	13.53	11.60	15.64	14.34	12.30
3.4	7.87	7.23	6.21	10.90	10.04	8.64	13.85	12.77	11.03	15.54	14.25	12.22		14.97	12.84

N.B. In the blank part, the value K is equal to K_0' .

Figures in Table 1-6 may be borrowed from the table the isotropic plate (e.g. Ref. 2).

than p_{oa} and here, the antisymmetric buckling (Fig. 1(c)) occurs. This limiting value γ_0 can be determined by introducing the expression (14) and (15) into Eq. (12), considering $p_{os} = p_{oa}$. Consequently,

$$\gamma_0 = 4(\alpha_0/n\pi)^2 \sqrt{\eta^2 + K_0(\alpha_0/n)^2 - 1} / \left\{ \frac{\tanh(u_1 b/2)}{u_1 b} - \frac{\tan(u_2 b/2)}{u_2 b} \right\} + K_0 \delta (\alpha_0/n)^2 \tag{16}$$

where

$$\left. \begin{aligned} u_1 b &= (n\pi/\alpha_0) \sqrt{\eta + \sqrt{\eta^2 + K_0(\alpha_0/n)^2 - 1}} \\ u_2 b &= (n\pi/\alpha_0) \sqrt{-\eta + \sqrt{\eta^2 + K_0(\alpha_0/n)^2 - 1}} \end{aligned} \right\} \tag{17}$$

γ_0 is a function of α_0 , δ and η . In Fig. 4 to Fig. 6, γ_0 is plotted against α_0 for various values of η and δ . These curves are shown as smooth lines approximately. Strictly speaking, they are not smooth lines but consist of curved sections relating to the number of half wave $n_1 = 1, 2, \dots$. But, as mentioned above, the value K_0 in Eq. (16) and Eq. (17) is close to the value K_0' and we can approximately introduce K_0' instead of K_0 into Eq. (16) and Eq. (17). Then, γ_0 obtained in this manner is represented by smooth curves which are independent for n_1 . The error basing on this simplified computation is negligible.

It is apparent from the diagrams that according to the increase of η or δ , the maximum value of γ_0 , say $\gamma_{0 \max}$, is increased and the value of α_0 which corresponds to the $\gamma_{0 \max}$ is increased.

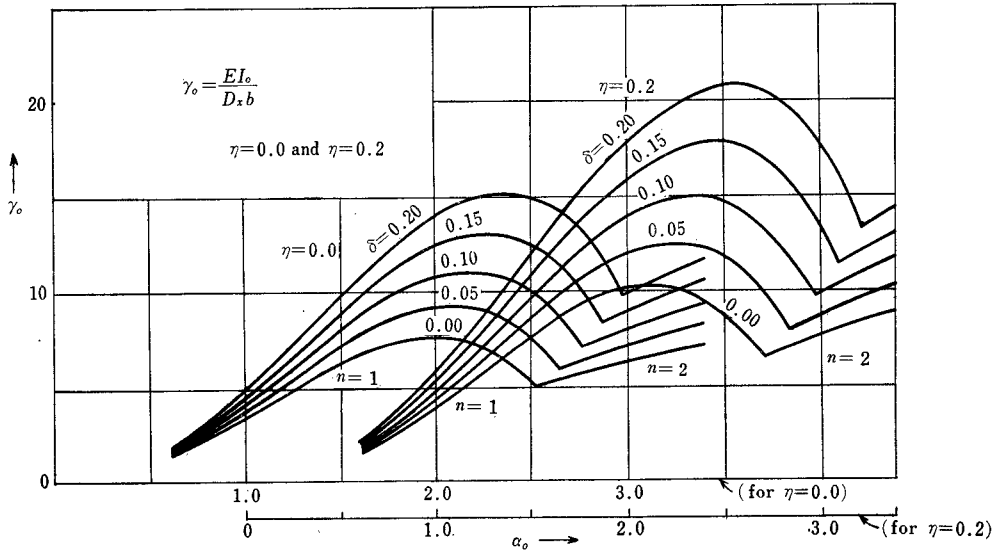

Fig. 4 The curves of the limiting value γ_0 for the case of one longitudinal girder on the center line ($\eta = 0.0$ and $\eta = 0.2$).

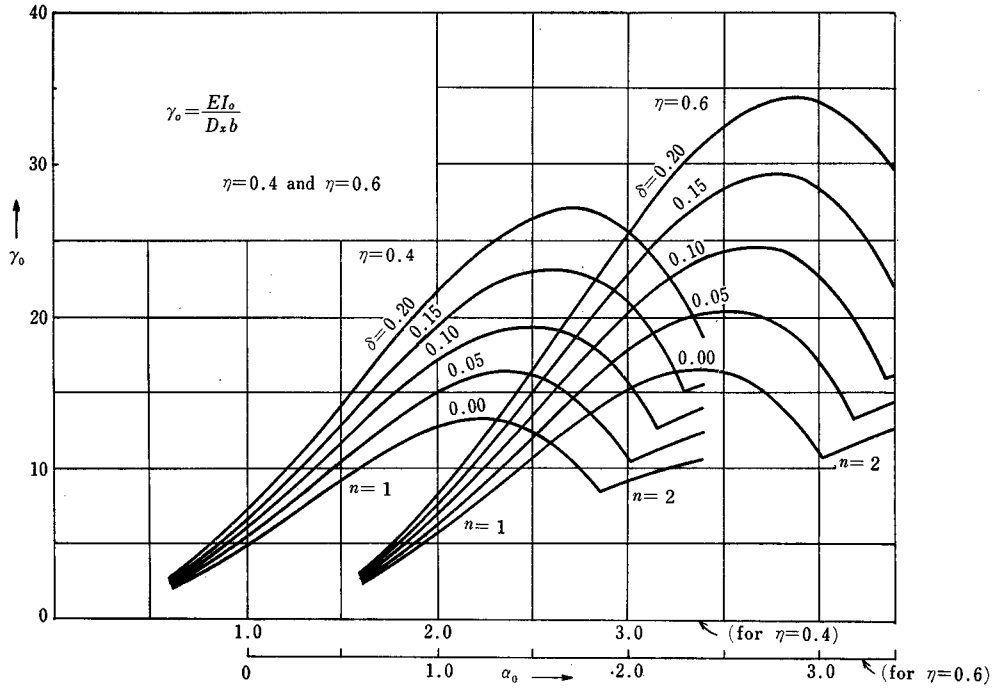

Fig. 5 The curves of the limiting value γ_0 for the case of one longitudinal girder on the center line ($\eta=0.4$ and $\eta=0.6$).

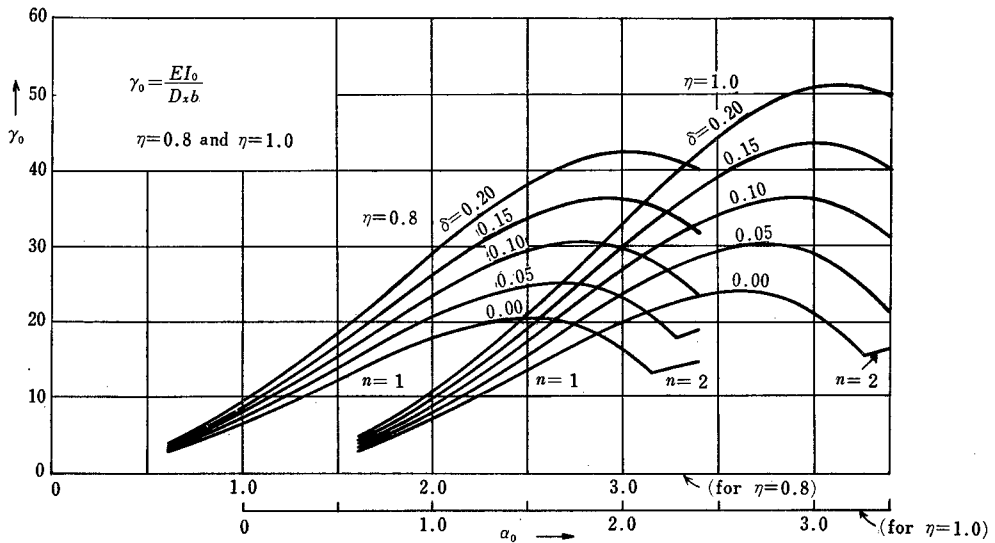

Fig. 6 The curves of the limiting value γ_0 for the case of one longitudinal girder on the center line ($\eta=0.8$ and $\eta=1.0$).

2-2. Simply supported orthotropic plate having one transverse girder on the center line

Consider a simply supported rectangular orthotropic plate of length a , width b , and

thickness t , which is reinforced by a transverse girder on the center line (see Fig. 7(a)). The moment of inertia of the girder is I . It is assumed that the center line of the girder lies in the middle plane of the plate, and the moment of inertia I , therefore, refers to the axis of the girder in this plane.

The torsional rigidity of the girder is regarded as small and will be neglected. We select a system of coordinates x, y having its origin O in the center of the upper edge of the plate. The plate is loaded by a uniformly distributed load pt acting on the edges $x = -a/2$ and $x = a/2$. The girder is assumed fixed to the plate.

In the region of $\alpha_0 \leq \sqrt{2}$, (as stated later) the symmetric configuration with the deflected girder (Fig. 7(b)) will occur when the flexural rigidity EI is small, and the antisymmetric configuration where the girder remains straight (Fig. 7(c)) will occur when the flexural rigidity EI is larger than a certain value EI_0 .

Here, we investigate the symmetric configuration of the buckled plate in order to derive the condition of instability. We take the deflection surface of the right half of the plate, ($x \geq 0$), in the form

$$w_1 = X(x) \sin(\pi y/b) \tag{18}$$

$$X(x) = C_1 \cos \bar{u}_1 x + C_2 \sin \bar{u}_1 x + C_3 \cos \bar{u}_2 x + C_4 \sin \bar{u}_2 x \tag{19}$$

where

$$\left. \begin{aligned} \bar{u}_1 a &= \pi \alpha_0 \sqrt{(K/2 - \eta) + \sqrt{(K/2 - \eta)^2 - 1}} \\ \bar{u}_2 a &= \pi \alpha_0 \sqrt{(K/2 - \eta) - \sqrt{(K/2 - \eta)^2 - 1}} \\ \alpha_0 &= (a/b) \sqrt[4]{D_y/D_x}, \quad \eta = H/\sqrt{D_x D_y} \\ K &= ptb^2/(\pi^2 \sqrt{D_x D_y}) \\ C_1 \text{ to } C_4 &= \text{integral constants.} \end{aligned} \right\} \tag{20}$$

Proceeding as before and using notation

$$\gamma = EI/(D_y a) \tag{21}$$

where γ is the ratio of the flexural rigidity of the girder to that of the plate of width a in the y direction, we obtain homogeneous linear equations for the constants C_1 to C_4 . The determinant of the system of equations furnishes the stability condition for the symmetric mode of buckling;

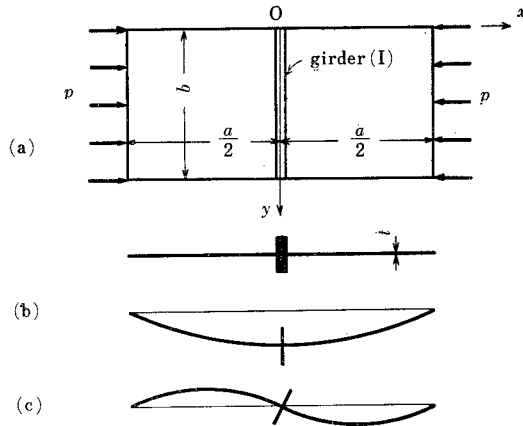

Fig. 7 Buckling of the simply supported orthotropic plate having one transverse girder on the center line.

$$2(\bar{u}_1^2 a^2 - \bar{u}_2^2 a^2) - \gamma(\pi\alpha_0)^4 \left\{ \frac{\tan(\bar{u}_2 a/2)}{\bar{u}_2 a} - \frac{\tan(\bar{u}_1 a/2)}{\bar{u}_1 a} \right\} = 0 \tag{22}$$

The numerical results for the value of p_{cs} , are shown in Table 2-1 to Table 2-6. As an example, the result for $\eta=0.6$ is shown in Fig. 8 for various values of γ . It is apparent from the Tables and diagram that for the constant value of η , the values of K are increased according to the increase of γ , and for the constant value of γ , the values of K are increased according to the increase of η . (When the value of η is increased by $\Delta\eta$, the values of K are increased by $2\Delta\eta$.)

In the antisymmetric configuration, each panel of the plate behaves like a simply supported plate of length $a/2$ and critical stress p_{cs} in this case is given by

$$p_{cs} = \{ \pi^2 \sqrt{D_x D_y} / (tb^2) \} K_0 \tag{23}$$

where

$$K_0 = (\alpha_0/2)^2 + 2\eta + (2/\alpha_0)^2. \tag{24}$$

In Table 2-1 to Table 2-6 and Fig. 8, K_0 is shown too.

In same manners as 2-1., when γ is small, p_{cs} is smaller than p_{cs} and then, symmetric buckling (Fig. 7(b)) occur, and when γ is larger than a certain value γ_0 , p_{cs} is larger than

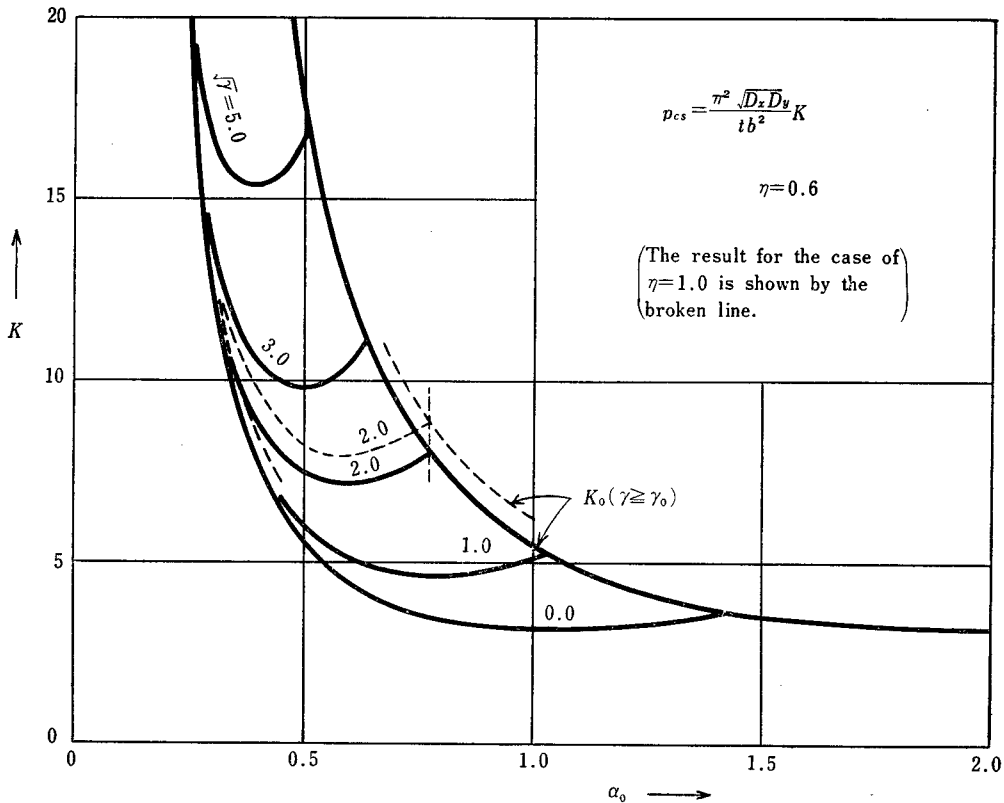

Fig. 8 The critical stress of the simply supported orthotropic plate having one transverse girder on the center line (in the case of $\eta=0.6$).

Table 2-1 to Table 2-3

The critical stress of the simply supported orthotropic plate having one transverse girder on the center line ($\eta=0.0$, $\eta=0.2$ and $\eta=0.4$).

The values of K are shown as $p = \{\pi^2 \sqrt{D_x D_y} / (tb^2)\} K$.

$\eta=0.0$

$\alpha_0 \backslash \sqrt{\gamma}$	0.25	0.50	0.75	1.00	1.50	2.00	2.50	3.00	4.00	5.00	6.00
0.3	11.22	11.25	11.30	11.38	11.61	11.92	12.32	12.82	14.07	15.67	17.61
0.4	6.43	6.49	6.64	6.73	7.13	7.68	8.40	9.27	11.46	14.22	17.51
0.5	4.28	4.37	4.53	4.75	5.37	6.23	7.38	8.66	11.92	15.85	16.06
0.6	3.19	3.32	3.54	3.86	4.74	5.96	7.50	9.30	11.20	11.20	11.20
0.7	2.59	2.77	3.08	3.51	4.68	6.30	8.22	8.29	8.29	8.29	8.29
0.8	2.28	2.52	2.91	3.46	4.97	6.41	6.41	6.41	6.41	6.41	6.41
1.0	2.13	2.49	3.09	3.91	4.25	4.25	4.25	4.25	4.25	4.25	4.25
1.2	2.31	2.84	3.14	3.14	3.14	3.14	3.14	3.14	3.14	3.14	3.14

N.B. The values of K below the horizontal lines are equal to K_0 .

$\eta=0.2$

$\alpha_0 \backslash \sqrt{\gamma}$	0.25	0.50	0.75	1.00	1.50	2.00	2.50	3.00	4.00	5.00	6.00
0.3	11.62	11.65	11.70	11.78	12.01	12.32	12.72	13.22	14.47	16.07	18.01
0.4	6.83	6.89	7.04	7.13	7.53	8.08	8.80	9.67	11.86	14.62	17.91
0.5	4.68	4.77	4.93	5.15	5.77	6.63	7.78	9.06	12.32	16.25	16.46
0.6	3.59	3.72	3.94	4.26	5.14	6.36	7.90	9.70	11.60	11.60	11.60
0.7	2.99	3.17	3.48	3.91	5.08	6.70	8.62	8.69	8.69	8.69	8.69
0.8	2.68	2.92	3.31	3.86	5.37	6.81	6.81	6.81	6.81	6.81	6.81
1.0	2.53	2.89	3.49	4.31	4.65	4.65	4.65	4.65	4.65	4.65	4.65
1.2	2.71	3.24	3.54	3.54	3.54	3.54	3.54	3.54	3.54	3.54	3.54

N.B. The values of K below the horizontal lines are equal to K_0 .

$\eta=0.4$

$\alpha_0 \backslash \sqrt{\gamma}$	0.25	0.50	0.75	1.00	1.50	2.00	2.50	3.00	4.00	5.00	6.00
0.3	12.02	12.05	12.10	12.18	12.41	12.72	13.12	13.62	14.87	16.47	18.41
0.4	7.23	7.29	7.44	7.53	7.93	8.48	9.20	10.07	12.26	15.02	18.31
0.5	5.08	5.17	5.33	5.55	6.17	7.03	8.18	9.46	12.72	16.65	16.86
0.6	3.99	4.12	4.34	4.66	5.54	6.76	8.30	10.10	12.00	12.00	12.00
0.7	3.39	3.57	3.88	4.31	5.48	7.10	9.02	9.09	9.09	9.09	9.09
0.8	3.08	3.32	3.71	4.26	5.77	7.21	7.21	7.21	7.21	7.21	7.21
1.0	2.93	3.29	3.89	4.71	5.05	5.05	5.05	5.05	5.05	5.05	5.05
1.2	3.11	3.64	3.94	3.94	3.94	3.94	3.94	3.94	3.94	3.94	3.94

N.B. The values of K below the horizontal lines are equal to K_0 .

Table 2-4 to Table 2-6

The critical strees of the simply supported orthotropic plate having one transverse girder on the center line ($\eta=0.6$, $\eta=0.8$ and $\eta=1.0$).

The values of K are shown as $p = \{\pi^2 \sqrt{D_x D_y} / (bt^3)\} K$.

$\eta=0.6$

$\alpha_0 \backslash \sqrt{\gamma}$	0.25	0.50	0.75	1.00	1.50	2.00	2.50	3.00	4.00	5.00	6.00
0.3	12.42	12.45	12.50	12.58	12.81	13.12	13.52	14.02	15.27	16.87	18.81
0.4	7.63	7.69	7.84	7.93	8.33	8.88	9.60	10.47	12.66	15.42	18.71
0.5	5.48	5.57	5.73	5.95	6.57	7.43	8.58	9.86	13.12	17.05	17.26
0.6	4.39	4.52	4.74	5.06	5.94	7.16	8.70	10.50	12.40	12.40	12.40
0.7	3.79	3.97	4.28	4.71	5.88	7.50	9.42	9.49	9.49	9.49	9.49
0.8	3.48	3.72	4.11	4.66	6.17	7.61	7.61	7.61	7.61	7.61	7.61
1.0	3.33	3.69	4.29	5.11	5.45	5.45	5.45	5.45	5.45	5.45	5.45
1.2	3.51	4.04	4.34	4.34	4.34	4.34	4.34	4.34	4.34	4.34	4.34

N.B. The values of K below the horizontal lines are equal to K_0 .

$\eta=0.8$

$\alpha_0 \backslash \sqrt{\gamma}$	0.25	0.50	0.75	1.00	1.50	2.00	2.50	3.00	4.00	5.00	6.00
0.3	12.82	12.85	12.90	12.98	13.21	13.52	13.92	14.42	15.67	17.27	19.21
0.4	8.03	8.09	8.24	8.33	8.73	9.28	10.00	10.87	13.06	15.82	19.11
0.5	5.88	5.97	6.13	6.35	6.97	7.83	8.98	10.26	13.52	17.45	17.66
0.6	4.79	4.92	5.14	5.46	6.34	7.56	9.10	10.90	12.80	12.80	12.80
0.7	4.19	4.37	4.68	5.11	6.28	7.90	9.82	9.89	9.89	9.89	9.89
0.8	3.88	4.12	4.51	5.06	6.57	8.01	8.01	8.01	8.01	8.01	8.01
1.0	3.73	4.09	4.69	5.51	5.85	5.85	5.85	5.85	5.85	5.85	5.85
1.2	3.91	4.44	4.74	4.74	4.74	4.74	4.74	4.74	4.74	4.74	4.74

N.B. The values of K below the horizontal lines are equal to K_0 .

$\eta=1.0$

$\alpha_0 \backslash \sqrt{\gamma}$	0.25	0.50	0.75	1.00	1.50	2.00	2.50	3.00	4.00	5.00	6.00
0.3	13.22	13.25	13.30	13.38	13.61	13.92	14.32	14.82	16.07	17.67	19.61
0.4	8.43	8.49	8.64	8.73	9.13	9.68	10.40	11.27	13.46	16.22	19.51
0.5	6.28	6.37	6.53	6.75	7.37	8.23	9.38	10.66	13.92	17.85	18.06
0.6	5.19	5.32	5.54	5.86	6.74	7.96	9.50	11.30	13.20	13.20	13.20
0.7	4.59	4.77	5.08	5.51	6.68	8.30	10.22	10.29	10.29	10.29	10.29
0.8	4.28	4.52	4.91	5.46	6.97	8.41	8.41	8.41	8.41	8.41	8.41
1.0	4.13	4.49	5.09	5.91	6.25	6.25	6.25	6.25	6.25	6.25	6.25
1.2	4.31	4.84	5.14	5.14	5.14	5.14	5.14	5.14	5.14	5.14	5.14

N.B. The values of K below the horizontal lines are equal to K_0 .

$p_{0\alpha}$ and here, the antisymmetric buckling (Fig. 7(c)) occurs. This limiting value γ_0 can be determined by introducing the expression (23) and (24) into Eq. (22); considering $p_{0s} = p_{0\alpha}$. Consequently,

$$\gamma_0 = (16 - \alpha_0^4) / \{4\pi\alpha_0^2 \tan(\pi\alpha_0^2/4)\}. \tag{25}$$

From this expression, it is seen that γ_0 does not depend on η but γ_0 is determined by α_0 alone. The relation between γ_0 and α_0 is shown in Fig. 9. From this diagram, it is seen that γ_0 vanishes at $\alpha_0 = \sqrt{2}$. This means that in the region of $\alpha_0 \geq \sqrt{2}$, even without the girder the plate deflects in an antisymmetric configuration; hence the flexural rigidity of the transverse girder bisecting the plate has no effect whatsoever on the magnitude of the critical stress. (This discussion is valid up to the point of $\alpha_0 = \sqrt{6}$.)

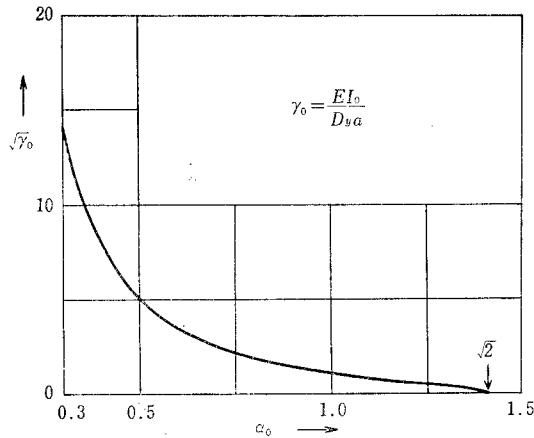

Fig. 9 The curve of the limiting value γ_0 for the case of one transverse girder on the center line,

2-3. The effective breadth of the orthotropic plate

In the above-mentioned calculation, it was assumed that the center line of the girder lay in the middle plane of the plate. But in many practical cases, the girder is attached to one side of the plate and is unsymmetry with respect to the middle plane of the plate in such a manner as shown in Fig. 10. Then, for the calculation of the flexural rigidity EI of the girder in this a case, the effective breadth b_e of the plate which cooperates with the girder as a part of a composite beam, must be estimated.

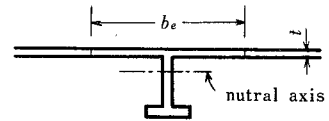

Fig. 10 The girder and plating.

The effective breadth of the plate, which is simply supported along the boundary as shown in Fig. 11 is approximated by that of the plate in which girders are arranged in the same direction with equi-distance s as shown in Fig. 12. The accuracy of this approximation for isotropic plate is assured in the Reference 3). For the sake of simplicity of the calculation, we treat the plate shown in Fig. 12.

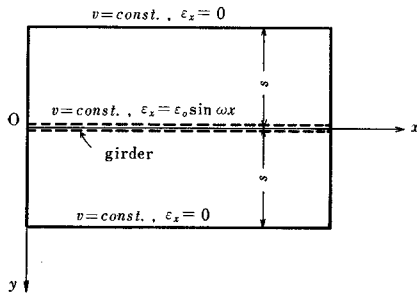

Fig. 11 The simply supported orthotropic plate having one longitudinal girder on the center line.

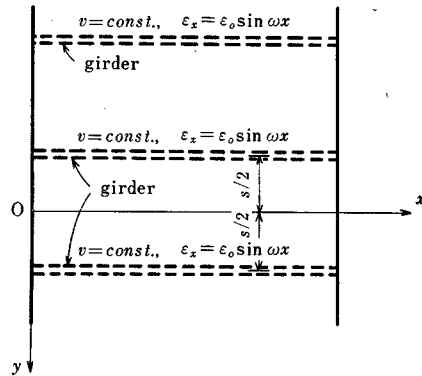

Fig. 12 The orthotropic plate having girders arranged in the same direction with equi-distance s .

Now, it is assumed that the orthotropic plates with girders deflect in sinusoidal waves (by λ we denote its one wave length), then the strain component ϵ_x of the plate in the x direction on the line of connection between plates and girders, is given by a form as

$$\epsilon_x = \epsilon_0 \sin \omega x \tag{26}$$

where

$$\left. \begin{aligned} \epsilon_0 &= \text{the constant value} \\ \omega &= 2\pi/\lambda \end{aligned} \right\} \tag{27}$$

Here, the girder is considered as a web which obeys the elementary beam theory. And the orthotropic plate is treated as a case of plane stress.

For the plate, the Airy's stress function F which satisfies

$$J_x \frac{\partial^4 F}{\partial x^4} + 2J_{xy} \frac{\partial^4 F}{\partial x^2 \partial y^2} + J_y \frac{\partial^4 F}{\partial y^4} = 0 \tag{28}$$

where

$$\begin{aligned} J_x &= 1/(E_y t), \quad J_y = 1/(E_x t) \\ 2J_{xy} &= 1/(Gt) - \nu_x J_y - \nu_y J_x \end{aligned}$$

is employed. Considering Eq. (26), we take for F in the part of plate between the girders, ($-s/2 \leqq y \leqq s/2$), a form as follows;

$$F = f(y) \sin \omega x \tag{29}$$

then, Eq. (28) requires that $f(y)$ takes a form as

$$f(y) = C_1 \cosh \beta_1 y + C_2 \sinh \beta_1 y + C_3 \cosh \beta_2 y + C_4 \sinh \beta_2 y \tag{30}$$

where

$$\left. \begin{aligned} \beta_1 &= \omega \rho \sqrt{\zeta + \sqrt{\zeta^2 - 1}}, \quad \beta_2 = \omega \rho \sqrt{\zeta - \sqrt{\zeta^2 - 1}} \\ \rho &= \sqrt[4]{J_x/J_y}, \quad \zeta = J_{xy}/\sqrt{J_x J_y}, \quad (\zeta \geqq 1) \\ C_1 \text{ to } C_4 &= \text{integral constants.} \end{aligned} \right\} \tag{31}$$

C_1 to C_4 are determined by the boundary conditions. Because of the symmetry with respect to the x axis, C_2 and C_4 vanish. Next, considering that displacement in the y direction is constant at $y = \pm s/2$

$$C_3 = - \frac{(\zeta + \sqrt{\zeta^2 - 1})(\zeta - \sqrt{\zeta^2 - 1} + \nu_w/\rho^2) \sinh(\beta_1 s/2)}{(\zeta + \sqrt{\zeta^2 - 1} + \nu_w/\rho^2) \sinh(\beta_2 s/2)} C_1 \quad (32)$$

When the ϵ_0 is given, the last unknown constant C_1 is determined by the condition of continuity on the line of connection between plate and girder.

$$[\epsilon_x]_{y=\pm s/2} = \epsilon_0 \sin \omega x \quad (34)$$

where

$$\epsilon_x = \left(\frac{\partial^2 F}{\partial y^2} - \nu_w \frac{\partial^2 F}{\partial x^2} \right) / E_x$$

But it is not necessary to calculate C_1 for the purpose of determination of the effective breadth b_e .

Here, assuming that the plate of the breadth b_e (its elastic constant is E_x) behaves as the *perfect* flange of the girder, the effective breadth b_e is defined by

$$b_e = \left(2 \int_0^{s/2} \sigma_x dy \right) / (E_x [\epsilon_x]_{y=\pm s/2}) \quad (35)$$

where

$$\sigma_x = \frac{\partial^2 F}{\partial y^2}$$

Substituting the value obtained above into Eq. (35), b_e is given by

$$b_e = \frac{\lambda}{\pi \rho} \cdot \frac{\xi \bar{\xi} \{ \cosh(\pi \rho \xi s / \lambda) - \cosh(\pi \rho \bar{\xi} s / \lambda) \}}{\xi \mu_1 \sinh(\pi \rho \xi s / \lambda) - \bar{\xi} \mu_2 \sinh(\pi \rho \bar{\xi} s / \lambda)} \quad (36)$$

where

$$\left. \begin{aligned} \xi &= \sqrt{\zeta + \sqrt{\zeta^2 - 1}} + \sqrt{\zeta - \sqrt{\zeta^2 - 1}} \\ \bar{\xi} &= \sqrt{\zeta + \sqrt{\zeta^2 - 1}} - \sqrt{\zeta - \sqrt{\zeta^2 - 1}} \\ \mu_1 &= 2(\zeta + 1) - (1 - \nu_w/\rho^2)^2 \\ \mu_2 &= 2(\zeta - 1) + (1 + \nu_w/\rho^2)^2 \end{aligned} \right\} \quad (37)$$

In this case, the effective breadth b_e takes a constant value along the x direction. When $s/\lambda \rightarrow 0$ or $s/\lambda \rightarrow \infty$, b_e is given as follows;

$$b_e/s = 1/(1 - \nu_w^2/\rho^4), \quad \text{when } s/\lambda \rightarrow 0, \quad (38)$$

$$b_e/\lambda = \xi/(\pi \rho \mu_1), \quad \text{when } s/\lambda \rightarrow \infty. \quad (39)$$

In the case of isotropic plate, b_e is obtained from Eq. (36) and (37) by $\rho \rightarrow 1$, $\zeta \rightarrow 1$, and $\nu_w = \nu$ as follows

$$b_e = \frac{\lambda}{\pi} \cdot \frac{4 \sinh^2(\pi s/\lambda)}{(1 + \nu) \{ (3 - \nu) \sinh(2\pi s/\lambda) - 2(1 + \nu) \pi s/\lambda \}} \quad (40)$$

which is in accordance with the value proposed in the paper quoted above.³⁾

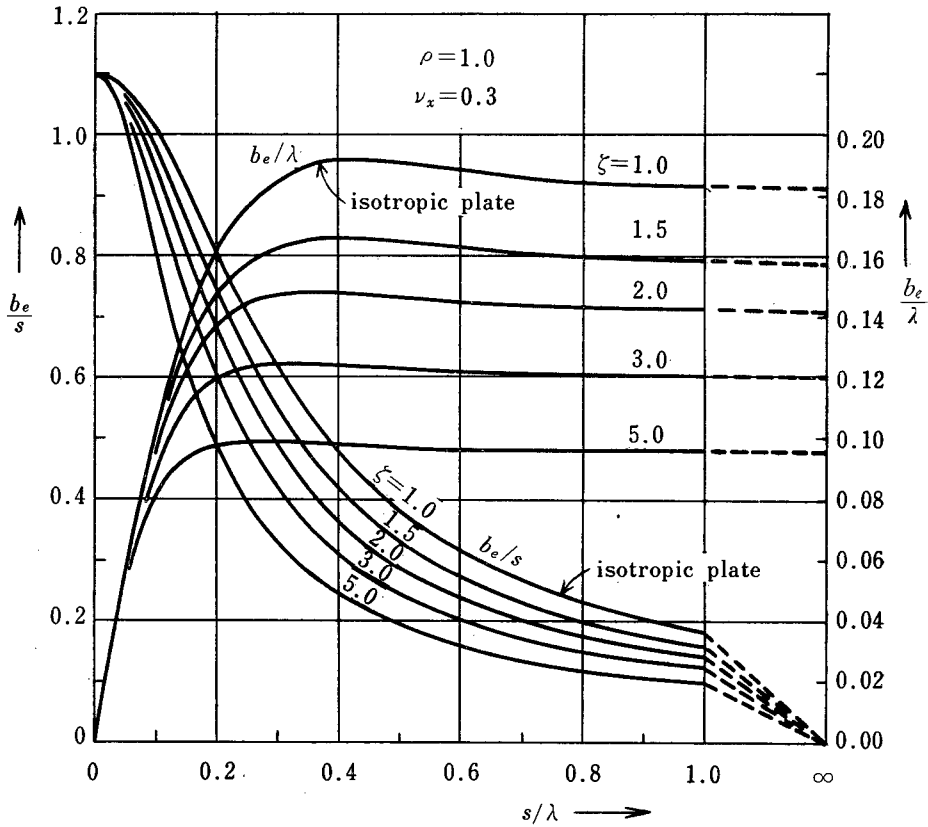

Fig. 13 The effective breadth of the orthotropic plate (in the case of $\rho=1$ and $\nu_x=0.3$).

As an example, Eq. (36) is plotted against s/λ for $\rho=1$ and $\nu_x=0.3$ with varying values of ζ in Fig. 13.

Putting $\lambda=2a/n$, $s=b/2$ (in the case of 2-1.) or $\lambda=2b$, $s=a/2$ (in the case of 2-2.), we may apply b_e given by Eq. (36) to the cases mentioned above. Though this effective breadth b_e is to be included in the calculation of the flexural rigidity EI , the effective breadth b_e must be excluded from the calculation of A (included in the expression of δ).

3. Application of the Theory to the Plate-Stiffener Combination System

The foregoing solution is expressed in terms of $D_x, D_y, H, J_x, J_y, J_{xy}$ or their combination. Accordingly, for the design of the plate-stiffener combination system, these coefficients must be determined as function of the stiffening system, dimensions of the stiffeners and the elastic properties of the plate and stiffeners. And many investigators⁴⁾⁻⁸⁾ have advanced formulae for determining the orthotropic plate rigidity coefficients.

Approximations concerning to bending properties of the plate are as follows;

$$D_x = E_x t^3 / \{12(1 - \nu_x \nu_y)\} = EI_x / S_x \tag{41}$$

$$D_y = E_y t^3 / \{12(1 - \nu_x \nu_y)\} = EI_y / S_y \tag{42}$$

where

E = elastic constant of the material.

$I_x, (I_y)$ = moment of inertia of the stiffener with effective plating* in the $x, (y)$ direction.

$S_x, (S_y)$ = spacing of the stiffener extending in the $x, (y)$ direction.

The coefficient η can be approximated by (due to Schade⁴)

$$\eta = H/\sqrt{D_x D_y} \approx \sqrt{I_{xx} I_{yy}} / (I_x I_y) \tag{43}$$

where

$I_{xx}, (I_{yy})$ = moment of inertia of the effective plating* only, working with stiffener, in the $x, (y)$ direction.

To apply the theory in **2-1.** and **2-2.** to the plate-stiffener combination system, we may use these approximations. Further, t , which is used in the expression of p, δ in **2-1.** and **2-2.,** may be replaced by t_x ; where t_x is the equivalent thickness composed of the plate and stiffeners (diffused), in the direction parallel to the compressive load.

The remaining coefficients J_x, J_y, J_{xy} which are used for determining the flexural rigidity EI of the girder, are roughly associated with the membrane properties of the plate^{5),7),8)} and can be approximated by (see Reference 8))

$$J_x = 1/(E_y t) \approx 1/(Et_y) \tag{44}$$

$$J_y = 1/(E_x t) \approx 1/(Et_x) \tag{45}$$

where

$t_x, (t_y)$ = equivalent thickness of the plate and the stiffener (diffused) in the $x, (y)$ direction.

$$J_{xy} = \{1/(Gt) - \nu_x J_y - \nu_y J_x\} / 2 \approx (1 + \nu)/(Et_p) - \nu/(Et) \tag{46}$$

where

$$\left. \begin{aligned} \bar{t} &= 2t_x t_y / (t_x + t_y) \\ t_p &= \text{thickness of the plate alone.} \end{aligned} \right\} \tag{47}$$

The coefficients $\rho (= \sqrt[4]{J_x/J_y})$ and $\zeta (= J_{xy}/\sqrt{J_x J_y})$ are approximately determined by using Eq. (44) to (46). And ν_x is approximately given by

$$\nu_x \approx (t_x + t_y)\nu / (2t_y) \tag{48}$$

With these coefficients, the effective breadth b_e can be determined from Eq. (36). (Here, the thickness of effective plating is the equivalent thickness in the direction parallel to the girder (Fig. 12), and the elastic constant is E .) Then, the ratio γ is determined and critical stress can be calculated.

* In this case, we may use Eq. (40), (or Fig. 13), which gives the effective breadth b_e for isotropic plates.

4. Conclusion

In this study, we considered the elastic buckling strength of a longitudinally compressed rectangular plate which is reinforced by orthogonally intersecting stiffeners and one longitudinal girder or transverse girder on the center line. The plate reinforced by orthogonally intersecting stiffeners is idealized by an equivalent orthotropic plate. And by means of the theory of the orthotropic plate, we obtained the critical stress for the symmetric buckling in the case of $\gamma < \gamma_0$ and determined the limiting value γ_0 . The effective breadth b_e of the orthotropic plate which cooperated with the girder and was necessary in the calculation of the flexural rigidity of the girder was also presented.

References

- 1) F. Bleich, *Buckling Strength of Metal Structures*, McGraw-Hill, New York (1952).
- 2) S. P. Timoshenko and J. M. Gere, *Theory of Elastic Stability*, 2nd Ed., McGraw-Hill, New York (1961).
- 3) K. Okuda and T. Arima, *Trans. J. S. N. A.*, **58**, 59 (1936).
- 4) H. A. Schade, *Trans. S. N. A. M. E.*, **49**, 154 (1941).
- 5) H. Köller, *Jahrb. d. Deutschen Versuchsanstalt f. Luftfahrt* (1939).
- 6) N. J. Huffington and Blackburg, *J. App. Mech.*, **23**, 15 (1956).
- 7) H. G. Schultz, *Jahrb. d. Schiffbautechnischen Gesellschaft*, **56**, 182 (1962).
- 8) A. Mansour, *I. S. P.*, **18**, 202 (1971).